

OWNER MANUAL

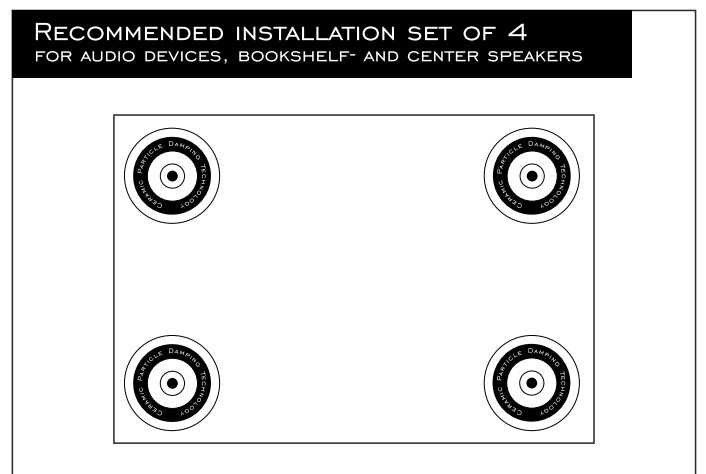

CERAMIC PARTICLE DAMPING TECHNOLOGY VIBRATION CONTROL SYSTEM

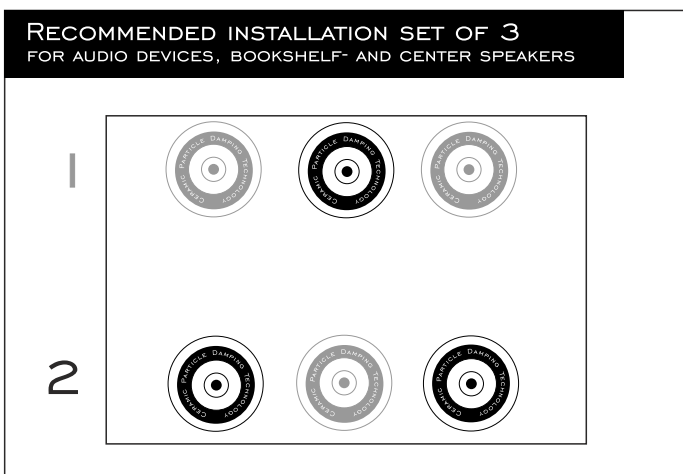
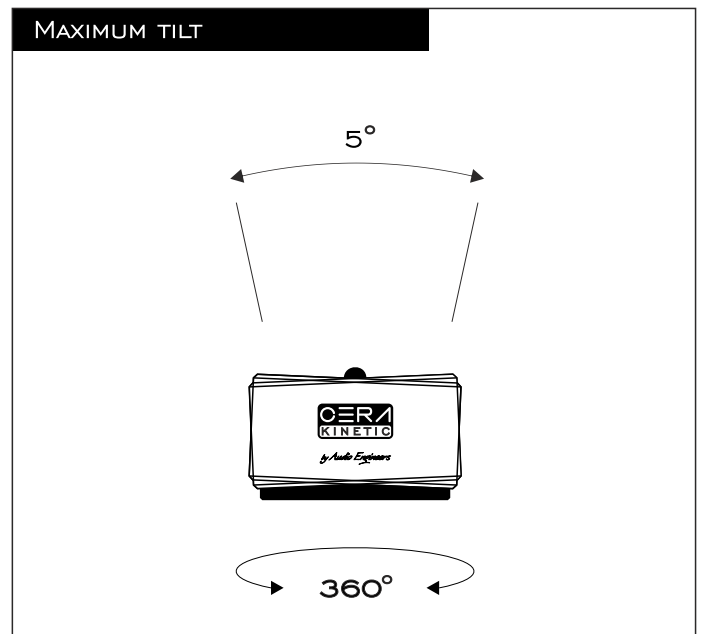
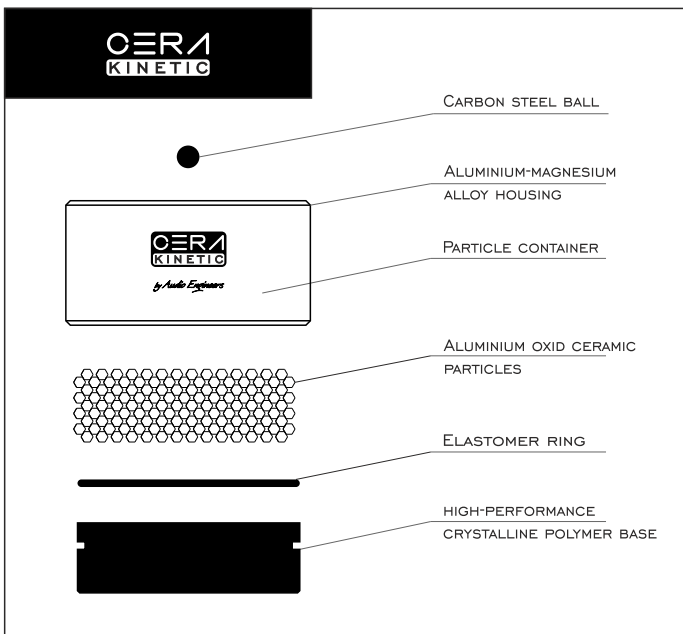
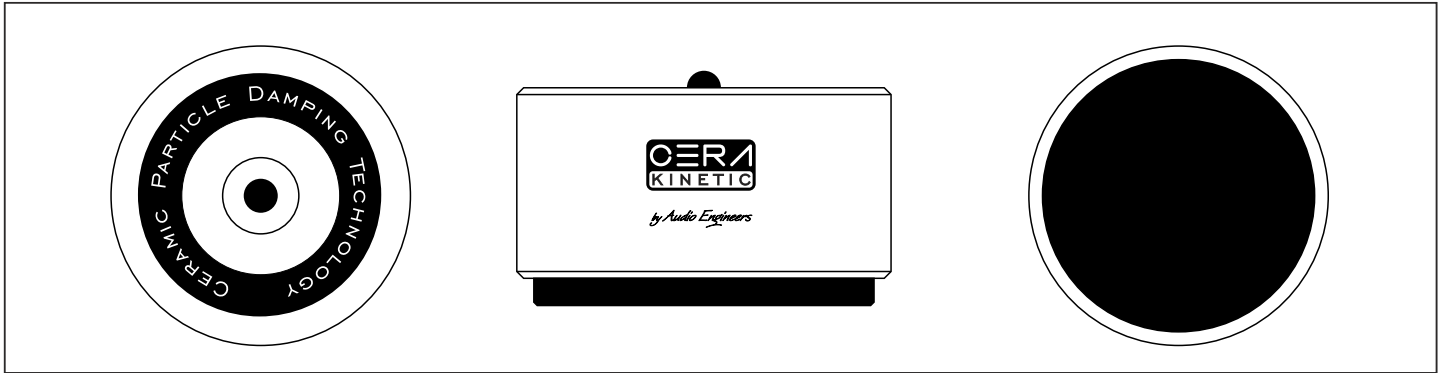

RECOMMENDED INSTALATIONS WITH CARBON STEEL BALL
FOR AUDIO DEVICES, BOOKSHELF- AND CENTER SPEAKERS

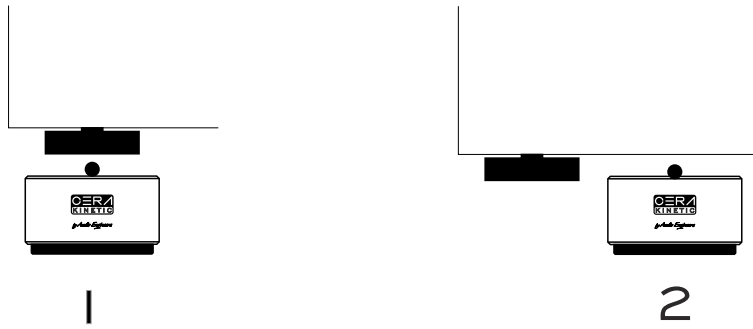

RECOMMENDED INSTALLATION SET OF 4
FOR FLOOR STAND SPEAKERS, STANDS AND MEDIA FURNITURE

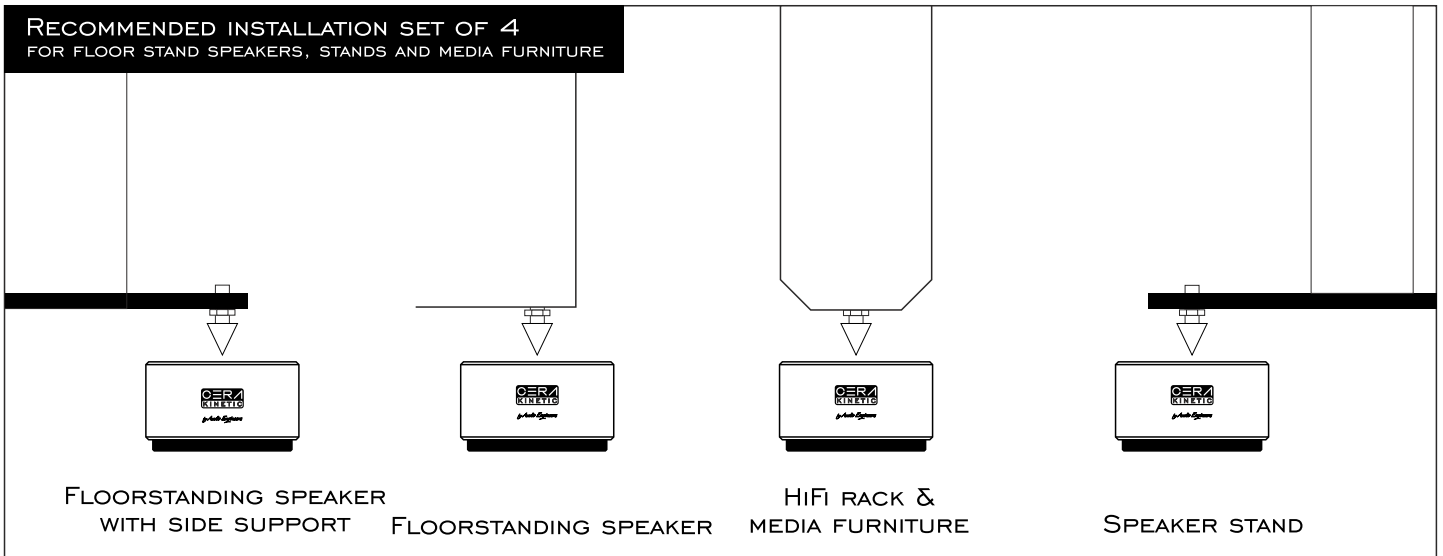

RECOMMENDED INSTALLATION SET OF 4
FOR FLOOR STAND SPEAKERS, STANDS AND MEDIA FURNITURE

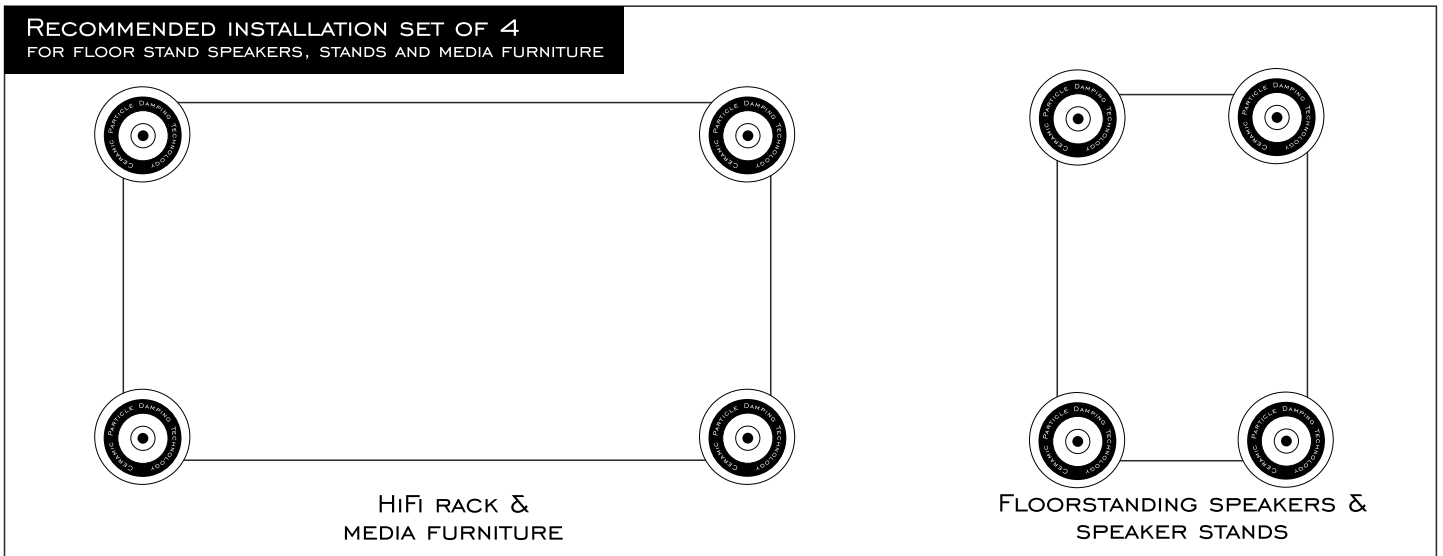

DESIGNED AND ENGINEERED IN THE UK.
MADE WITH PRECISION HAND ASSEMBLY IN THE EU.

SPECIFICATION:

- COLOR: SILK GRAY SHINE
- MATERIALS: ALUMINIUM-MAGNESIUM ALLOY, HIGH-PERFORMANCE CRYSTALLINE POLYMER, ALUMINIUM OXID CERAMIC GRAINS, CARBON STEEL, ELASTOMER
- DIMENSIONS: 1,75" x 1" / 45 x 26 MM
1,75 x 1,15 / 45 x 29,5 MM WITH UPPER CARBON STEEL BALL
- WEIGHT: 0,4LBS / 180G / 1 PC
- LOAD CAPACITY: 100LBS / 45KG / 1 PC

